

DIMENSIONS

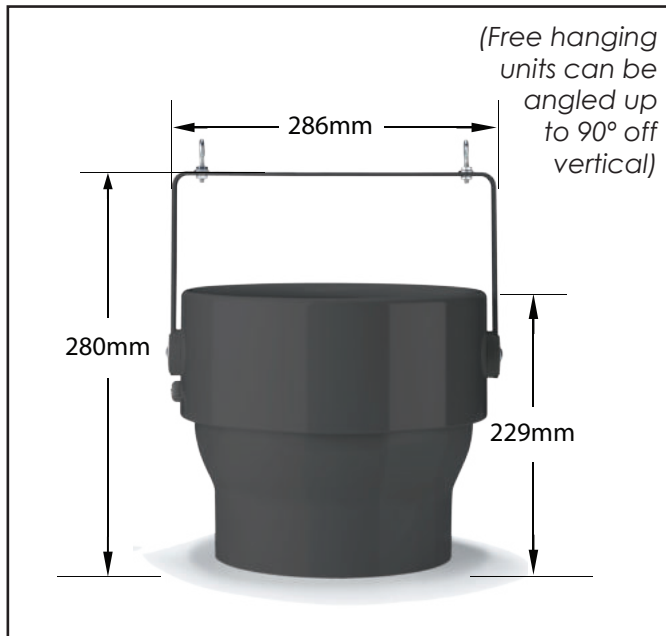

PROPERTIES

UNIT SIZE	Standard
Weight:	3.0 kgs
Height to Rim:	229 mm
Total Height:	280 mm
Diameter:	286 mm

MOTOR	230V
Watts* @ 50 htz:	15
RPM* @ 50 htz:	1230
L/S* @ 50 htz (m3/hr):	191 (690)
AMPS* @ 50 htz:	0.06

*Motor data provided by motor manufacturer and is subject to change at anytime

COVERAGE

- Ceiling Height = 3.5m - 4.5m (11 - 15 ft)
- Max Floor area = 60m² (645 ft²)

MOTOR

- Single phase, shaded pole, single speed (variable with optional speed control), axial motor
- Sealed bearings, no lubrication required

OPERATING TEMPERATURES

- Operating Temp = -20°C (-4°F) to 70°C (158°F)
- Thermal shut off = 110°C (230°F)
- Reset = 90°C (195°F)

HOUSING

- ABS Resin - Inc. internal fixed blade stator
- 5VA flame resistance rating
- 1.8m (6') steel safety leash cable (fastened to housing)

NOISE LEVEL

- 3 Metres = TBA

INGRESS PROTECTION

- IP55 Rated

COLOUR

- Black as standard
- Can be tailor painted to your colour specifications

SPEED CONTROLS

- Speed Controls - On/off speed controls allow for variable output from Airius unit. 1 AMP and 5 AMP controls available

WARRANTY

- 5 years parts and workmanship from shipping date
- 120 day money back guarantee (T's & C's apply)

PLACEMENT

PREPARATION

- Install electrical circuit(s) and outlet(s) in accordance with national and local electric codes
- Outlets should generally be mounted vertically unless a "twist/locking" type is being used
- Wall switch may be installed in circuit to disable power and prevent electrical hazards when servicing
- Confirm electrical continuity of Airius unit on the ground before permanently mounting in the ceiling

INSTALLATION

- Hang vertically as high in the ceiling as possible
Typically 300mm (12") - 450mm (18") from the roof deck to intake
- The Airius unit performs best when air column from the nozzle is unimpeded to the floor
- Use professionally installed hardware, capable of supporting a minimum of five times the weight
- Hardware to hang the unit includes but is not restricted to: Hooks, chains, cables, carabiners, bridle rings, beam clamps and bolts
- Density of the placement is directly related to the effectiveness, performance and savings
- Mount out of reach from people and animals
- Floor plans, mezzanines, office locations, machinery, people placement, plumbing, lighting, duct work, electrical systems, natural light/air systems, cranes, doors, windows, ventilation and fire suppression systems are all factors in properly locating the Airius system within the ceiling

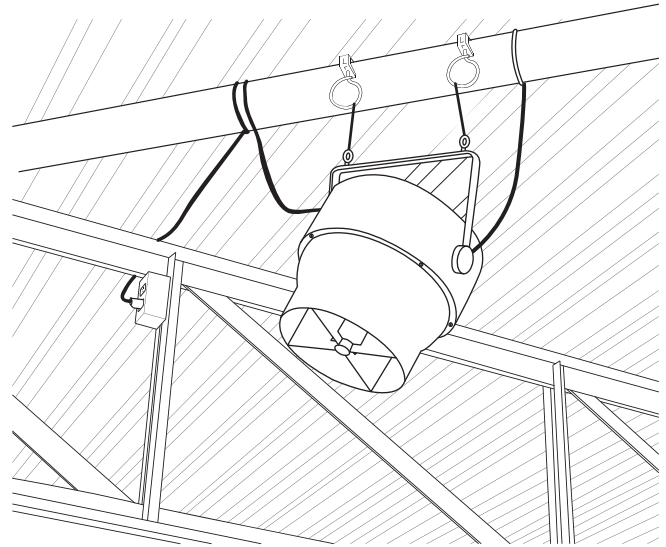

OPERATION

- Designed to operate 24 hours-a-day, 7 days-a-week to maintain thermal equalization/humidity equalization
- Use optional speed control to fine tune RPM if needed

MAINTENANCE

- Frequency of cleaning will vary by application and environment
- You may clean the plastic housing with a damp warm cloth, using mild household detergents
- Do not use petroleum products, thinners or solvents to clean any part of the Airius unit
- If the Airius unit fails, contact manufacturer



Airius LLC, © 2011. All Rights Reserved.